

The following sections review characteristics of the ridgeline access roads and the turbine access roads, and provide a discussion of the design measures included for the project. A discussion of construction and stormwater issues is provided in Appendix 2-K. Appendix 2-L provides the transportation management plan. Table 2-5 summarizes roadway technical specifications.

Table 2-5: Technical Specifications for Access Roads

Dimensions	
Turbine access roads	- Travelling surface 20 feet – 25 feet (6 – 7.6 m) - Side slopes 2H:1V (with exceptions)
Curves	- 26 feet width (7.9 m) - Distance between curves: 150 feet (45.7 m) - Minimum internal radius of curve: 150 feet (45.7 m) ¹
Ditches	- 1 to 2 feet (0.3–0.6 m) height - 2 to 6 feet (0.6–1.8 m) bottom width - Slope of sides 2:1 - Top width 6 to 14 feet (1.8 – 4.3 m)
Ridgeline access roads	- Travelling surface 34 feet (10.4 m) in width to allow crane to “crawl” between sites
Slope and Leveling	
Maximum slope for standard equipment	6%
Maximum slope for specialized equipment	6 to 10%
Limits of deviation	6 inch maximum over 140-foot (42.7 m) span of trailers ²

¹ The minimum distance between curves was a general goal but could not always be achieved due to geometric constraints and efforts made to minimize cut/fill and impacts to environmental features, particularly wetlands.

² Lengths of vertical crest curves were established to allow for a 6 to 9 inch clearance beneath the beds of the transport vehicles. This length varied based on the grades of the approach tangents on both sides of the vertical curve.

Ridgeline Access Roads

Existing and new access roads need to support the transport of heavy turbine tower sections, the 70-ton nacelles and the 144-foot (44-m) blades. Where the project will use existing roads, some improvements are necessary to ensure safe use of those roads during construction.

Along Gold Brook Road, where heavy logging traffic is common, special design measures will be incorporated. In general, the 25-foot (7.6-m) wide Gold Brook Road is of sufficient quality to support project construction needs. In select locations where sight distances warrant, TransCanada will coordinate with Plum Creek to facilitate localized roadway widening. In

addition, pull-off areas will be established along Gold Brook Road to allow for safe passing of road users during peak construction periods. Pull-offs will be located approximately every ½ mile along Gold Brook Road, on alternating sides of the road. Specific locations will be adjusted to avoid impact to wetlands and other natural resource area. It is estimated that each pull-off area will be approximately 20 feet (6 m) wide and 250 feet (76 m) long, and that about 15 such areas will be established. Following construction, these areas can be allowed to revegetate. Some existing bridges may need to be repaired or reinforced. All existing bridges will be inspected, and coordination with Plum Creek will target appropriate improvements.

The other existing major roadways do not see the level of traffic experienced routinely on Gold Brook Road. Therefore, few pull-off areas are required along those roadways. In general, Wahl Road and Spencer Bale Road are approximately 15 feet (4.6 m) wide under current conditions. To support project construction access and egress needs, sections of these roads will be widened to approximately 25 feet (7.6 m). Hurricane Road will be used only to access one section of collector line, so it will not experience the same type or volume of construction vehicle use as the other roads and will require only minor upgrades at the most.

The new access roads will be built as gravel roads, with 20- to 25-foot (6-m to 7.6-m) travel surfaces. Ditches or other measures will be provided for stormwater management. Vegetation may be cut back at the edges during construction to allow passage of wide loads. Design measures addressed below will be incorporated to ensure appropriate stabilization and hydrologic connection is maintained. A load-carrying capacity of 90 to 100 tons is required. Where rock is encountered, ripping or blasting will be utilized. Blasting will be performed safely and efficiently with minimal impact to areas adjacent to the blast sites. Blasting is discussed in Section 5.5.5.

Access to the A Series will be from two locations. The majority of the A Series turbines will be reached via a new access road originating at an unnamed road off of Gold Brook Road. To maintain appropriate grades, the new access road incorporates a switchback design. Location of the new access road was influenced by grade requirements, and has been adjusted to avoid wetland impact to the greatest extent possible. The second A Series access road runs off Spencer Bale Road. This provides access to the southernmost A Series turbine sites, and can take advantage of more gently sloping terrain in that area. There will be some minor wetland impact associated with this access, as discussed in Section 8.5.

Access to the B Series is also provided from two locations. Access to the westerly ridgeline of the B Series is provided by a new access road originating from an unnamed road off of Gold Brook Road. Existing slopes do not require a switchback design to reach the ridgeline summit. Selection of this road location was heavily influenced by the desire to minimize potential wetland impact. Though this new road does impact wetland, the impact has been greatly minimized through on-site validation of alternative access designs. Access to the easterly ridgeline of the B Series is a new access road originating from an unnamed road off of Wahl Road. Again, the design has worked with existing terrain, and no switchbacks are required. There are minor wetland impacts associated with the B Series, discussed in detail in Section 8.5.

Turbine Access Roads and Turbine Site Clearing

Each turbine site will be located in a one acre cleared area next to the turbine access road. The turbine foundation will be located at one end of the clearing and a level, compacted area will be constructed next to the turbine foundation for placement of the heavy lift crawler crane which will be used to erect the wind turbine. During construction, about 80 percent of the cleared area will be used as temporary work space storing tower sections in preparation for assembly and for assembly/disassembly of the main crane boom. An illustration of the turbine pad area is provided in Figure 2-9.

The turbine site and workspace locations have been selected to avoid wetlands, to ensure adequate spacing between turbines for wind energy reasons, and to avoid difficult slopes. Each location will be cleared and leveled to a grade of approximately 0.5 percent or less to accommodate the installation process.

Mountaintop roads connecting turbine sites must carry the same heavy loads as access roads, but must also be broad enough for transporting the wide-tracked heavy-lift erection crane. The crane will be brought to the site disassembled, and will be assembled near the first turbine pad. The crane will then travel from one site to the next as each turbine site is ready.

The turbine access roads will be built as gravel roads with the same 90 to 100 ton load-carrying capacity, but with 34-foot travel surfaces to allow for safe movement of the turbine erection crane. Following construction, only 20 feet of the 34-foot construction road width will be maintained. Specific stormwater control measures have been designed to suit the soils and topography of the area. Where rock is encountered, ripping or blasting will be utilized. Blasting is discussed in Section 5.5.5.

The specific roadway locations have incorporated site grade conditions as well as environmental factors. The turbine access roads for the A Series have been located and designed to avoid impact to wetland resources identified along that ridgeline. Along the B Series, wetland avoidance was also a high priority; only limited unavoidable impact occurs. In addition to wetland avoidance, specific design priority was afforded to an area identified as potential northern bog lemming habitat. Access roads were removed and rerouted to ensure that a 250-foot (76-m) buffer was maintained around this area, and that hydrological considerations could also be maintained. This issue is discussed in Section 7.4.1.3.

Drawings of access road details are provided in Figures 2-10, 2-11 and 2-12.

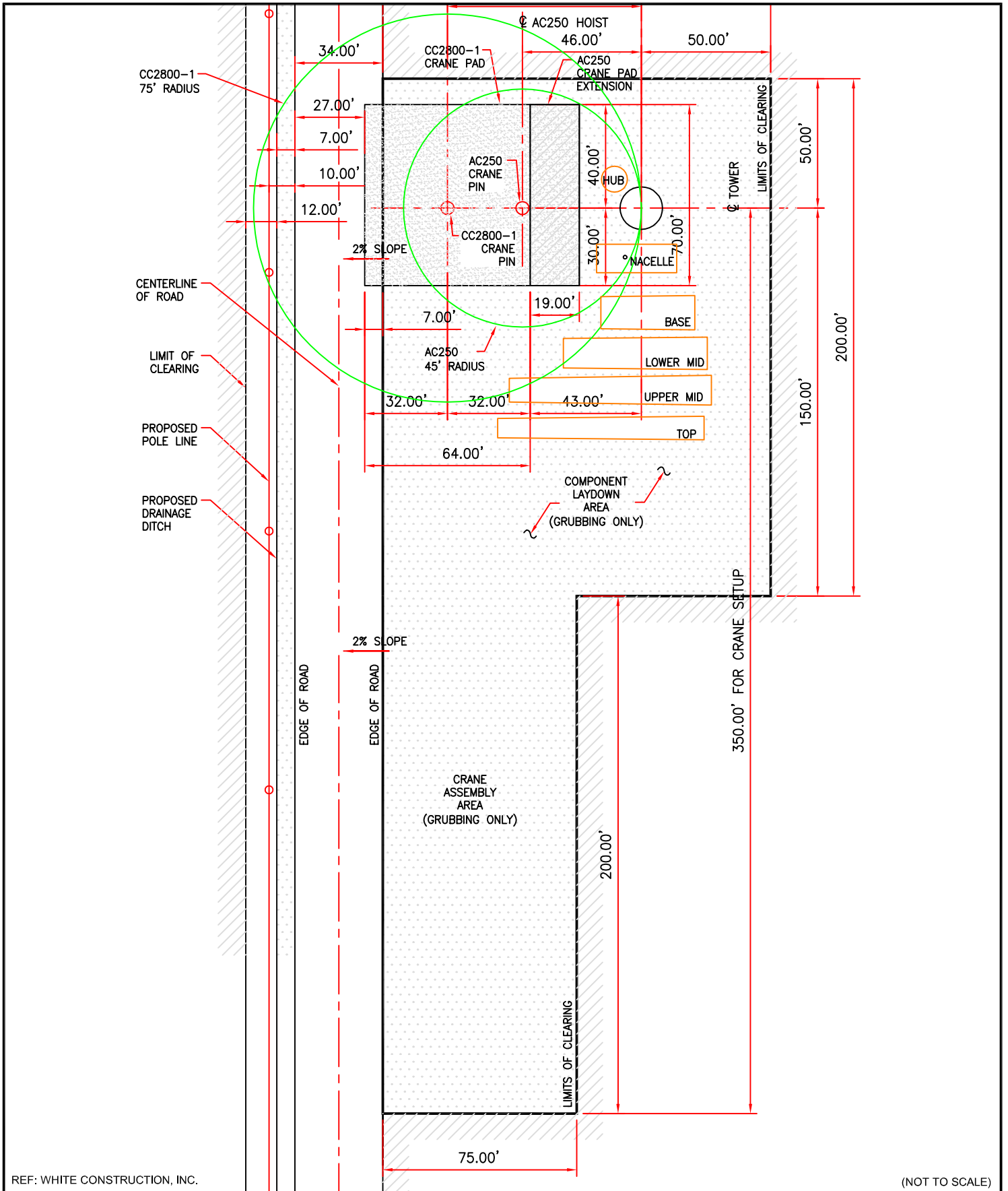

REF: WHITE CONSTRUCTION, INC.

(NOT TO SCALE)

Kibby Wind Power Project
Franklin County, Maine

Typical Turbine Pad Layout



EARTH & ENVIRONMENTAL, INC.
ONE PLYMOUTH MEETING, SUITE 850
PLYMOUTH MEETING, PA 19462-1308

Original: 11-28-06
Revision 1: 12-05-06

Drawing 11

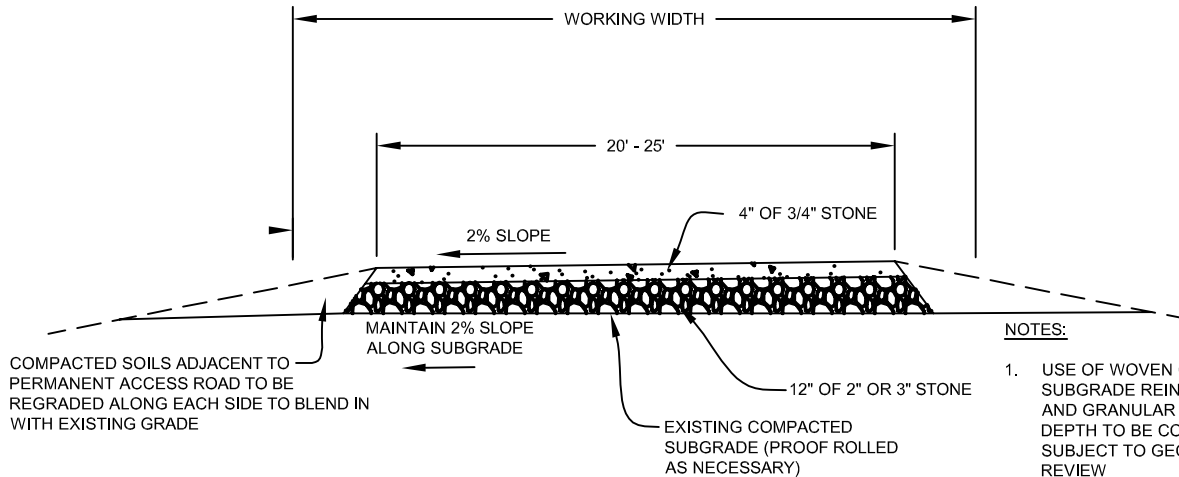

TYPICAL ACCESS ROAD CROSS SECTION
(NOT TO SCALE)

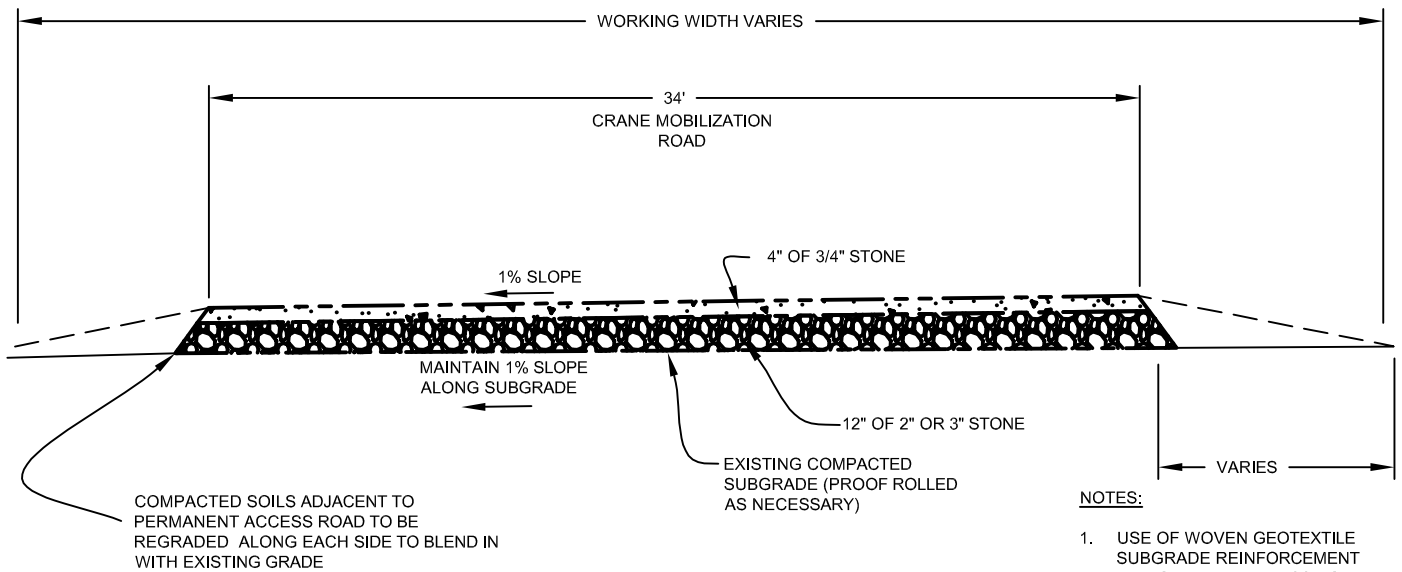

TYPICAL TURBINE ROAD CROSS SECTION
(NOT TO SCALE)

REF: WHITE CONSTRUCTION, INC., ROADS AND TRANSPORTATION SPECIFICATIONS, SECTION 6 (MODIFIED)

Kibby Wind Power Project
Franklin County, Maine

Typical Road Sections



EARTH & ENVIRONMENTAL, INC.
ONE PLYMOUTH MEETING, SUITE 850
PLYMOUTH MEETING, PA 19462-1308

Original: 11-28-06
Revision 1: 12-05-06
Revision 2: 12-19-06

Drawing 1

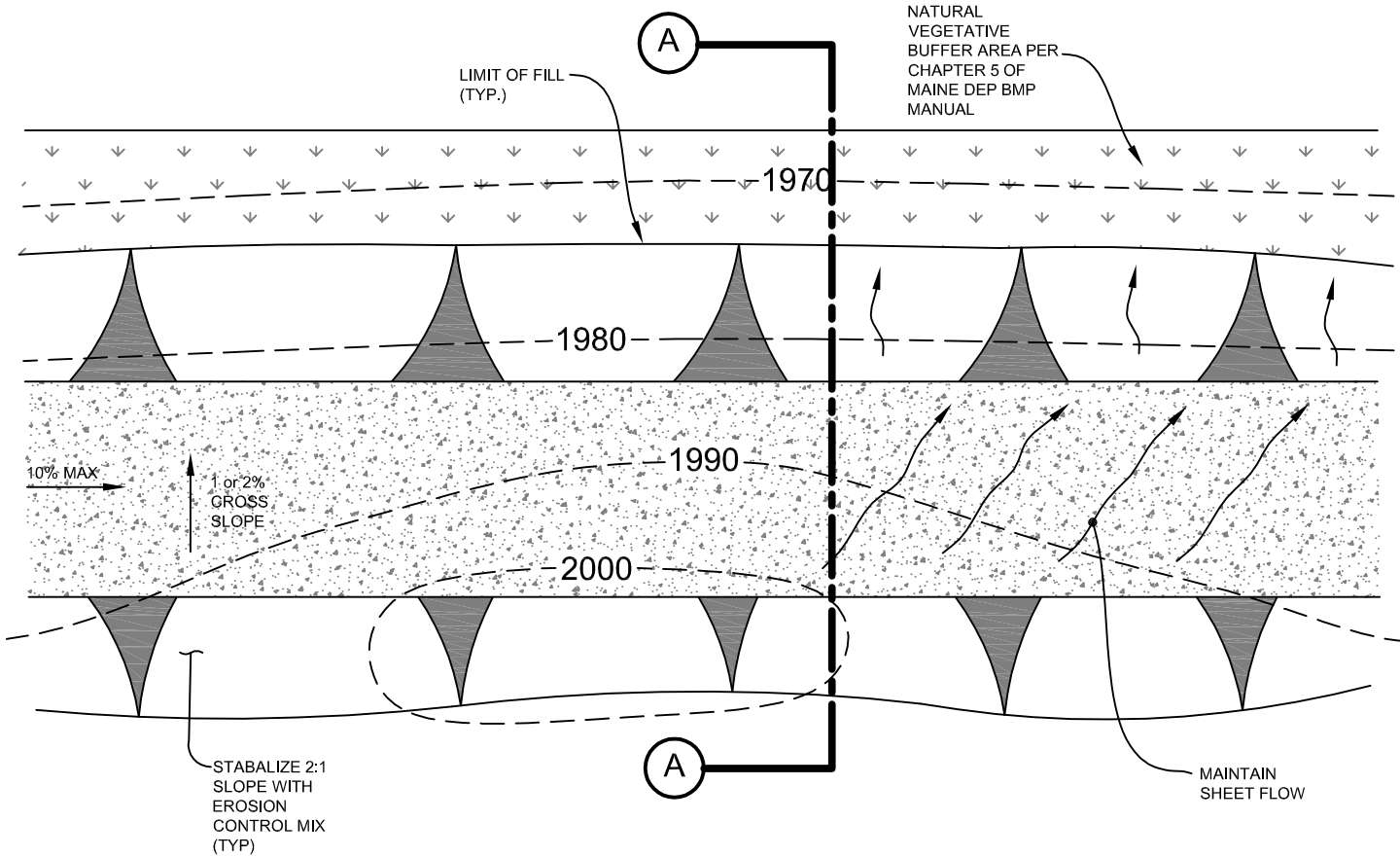

TYPICAL ROAD PLAN
(NOT TO SCALE)

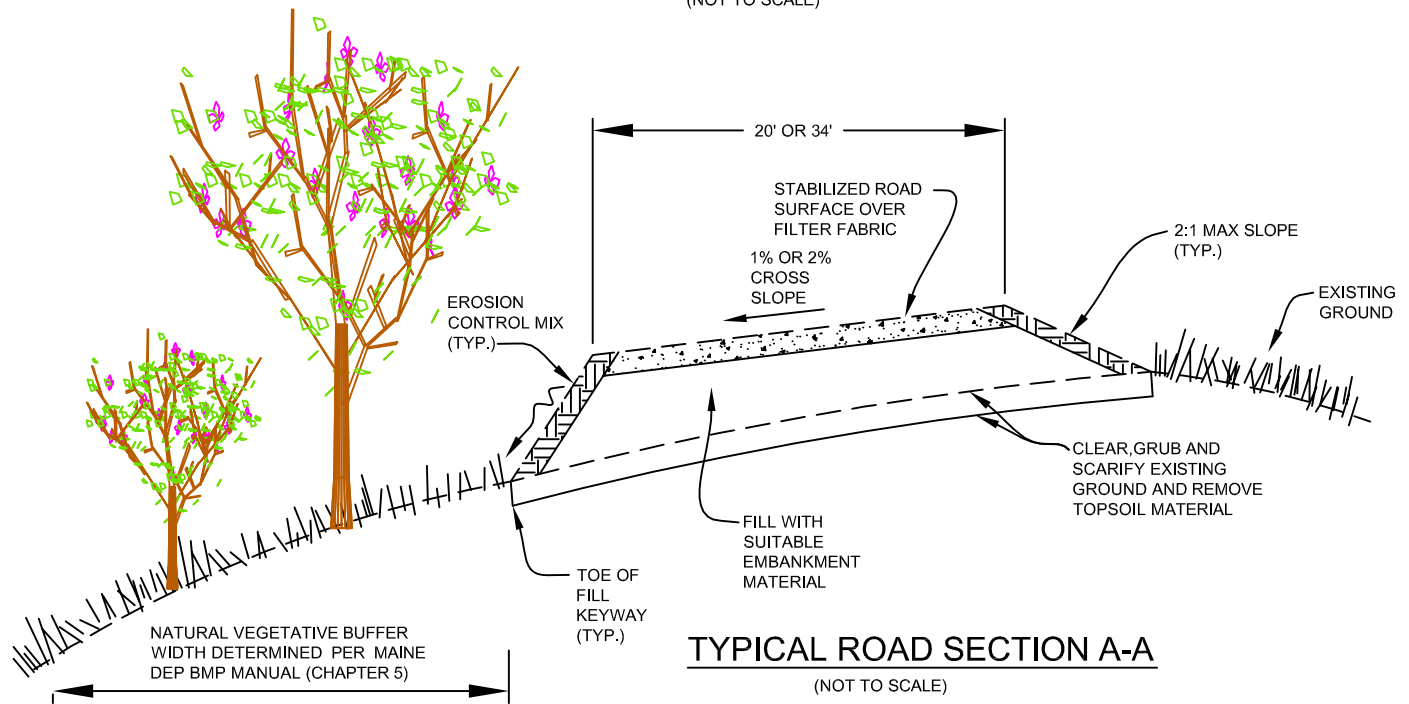

TYPICAL ROAD SECTION A-A
(NOT TO SCALE)

*FILL STROKES CAN BE MADE STEEPER PENDING GEOTECHNICAL EXPLORATION AND ENGINEERING ANALYSIS

Kibby Wind Power Project
Franklin County, Maine

**Typical Road Plan/
Section - All Fill**



EARTH & ENVIRONMENTAL, INC.
ONE PLYMOUTH MEETING, SUITE 850
PLYMOUTH MEETING, PA 19462-1308

Original: 11-28-06
Revision 1: 12-05-06

Drawing 3

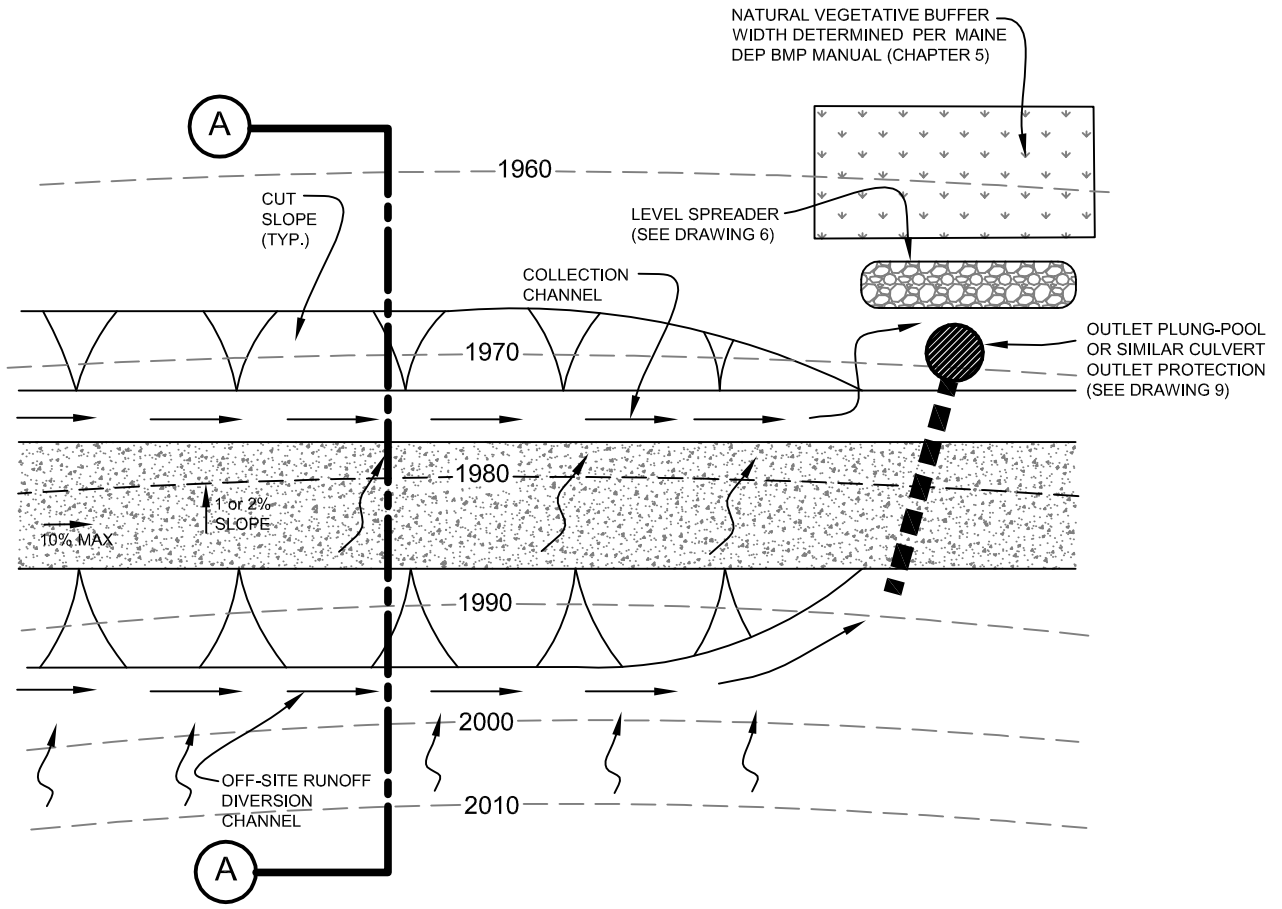

TYPICAL ROAD PLAN
(NOT TO SCALE)

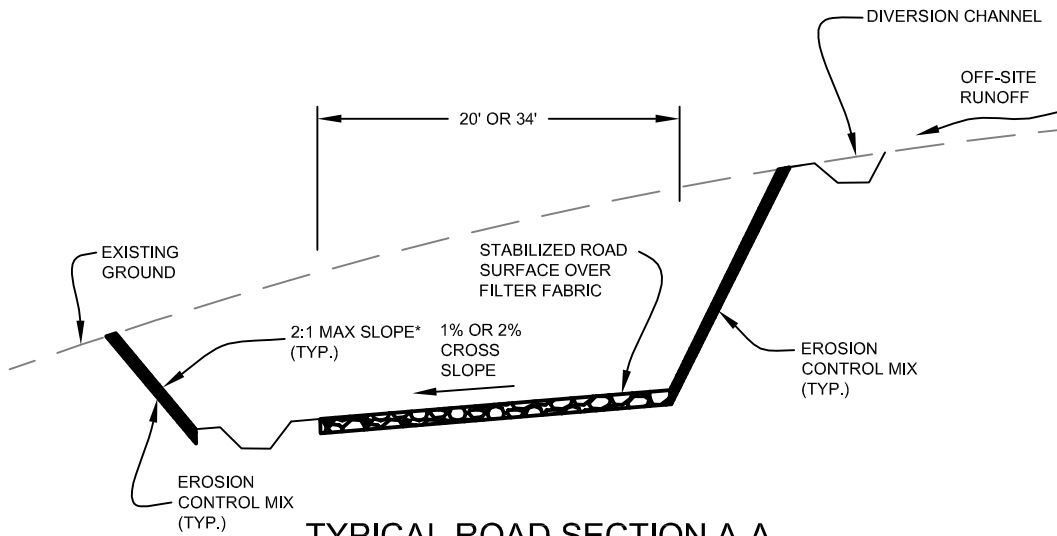

TYPICAL ROAD SECTION A-A
(NOT TO SCALE)

*CUT SLOPES MAY BE MADE STEEPER PENDING GEOTECHNICAL EXPLORATION AND ENGINEERING ANALYSIS

**IF ROADWAY CUTS INTO GROUNDWATER, MEASURES TO CONTROL / MANAGE SUBSURFACE DRAINAGE MAY BE REQUIRED

Kibby Wind Power Project
Franklin County, Maine

**Typical Road Plan/
Section - All Cut**



EARTH & ENVIRONMENTAL, INC.
ONE PLYMOUTH MEETING, SUITE 850
PLYMOUTH MEETING, PA 19462-1308

Original: 11-28-06
Revision 1: 12-05-06

Drawing 4

Kibby Wind Power Project Roadways – Portfolio of Design Measures

A range of potential design conditions have been reviewed to develop and apply appropriate construction techniques to varying terrain and drainage conditions. These techniques have been developed and modified through a series of site visits, meetings and discussions with regulatory agencies (including LURC, DEP and the Maine State Soil Scientist), as well as site review of on-going construction activity for similar projects in the area which occurred between May and December 2006.

Given the hydrology of the site, special design emphasis was placed on handling of surface runoff and subsurface drainage. In general, surface runoff will be handled by maintaining overland flow where possible and re-establishing overland flow where concentration of surface runoff is necessary, through the use of level spreaders. For subsurface drainage, measures are proposed to maintain subsurface drainage across the construction zone where cuts are occurring in areas of shallow groundwater to reduce potential for the creation of new seeps or springs. Such measures include a rock “sandwich” drainage blanket (Figure 2-13), as well as a series of drainage trenches (Figure 2-14). Typical road sections are illustrated in Figure 2-10, with all fill and all cut methods illustrated in Figure 2-11 and 2-12, respectively. Typical roadway drainage controls are shown in Figure 2-15, with typical culvert details illustrated in Figures 2-16 and 2-17. Stream crossing methods are illustrated in Figure 2-18. Although most wetland areas have been avoided, a few areas do exist where impact was unavoidable. In such areas, the crossing methods illustrated in Figure 2-19 will be employed. Typical erosion control measures are shown in Figure 2-20.

The specific locations where subsurface drainage methods will be employed will be refined once geotechnical exploration is completed. Based on current information, it is assumed that shallow groundwater exists below elevations 2,700 to 2,800 feet on Series A and below elevations 2,500 to 2,600 feet on Series B. Therefore, current design assumptions are that subsurface drainage techniques will be appropriate only along the newly proposed access roads. Construction of the roads between the turbines along the ridgelines will likely occur in areas where deeper groundwater and drainage characteristics will not necessitate the use of these measures. These drainage features will only be utilized where they will serve the important function of ensuring hydrology is maintained. Even once design plans are refined through geotechnical work, TransCanada will ensure that oversight of the construction effort by an on-site engineer will allow for appropriate adjustments to reflect field conditions. In this way, roadway construction can minimally affect hydrologic conditions at the site.

Kibby Wind Power Project Roadways – Stormwater Management

In general, stormwater management for the project has been designed to ensure that existing drainage patterns are maintained to the extent possible. Maintaining overland flow has been prioritized in the design, and permanent structures that would require on-going maintenance avoided where possible. Design measures have been identified that will be used as project refinements are made during the final design stage and through the construction effort in response to field conditions.

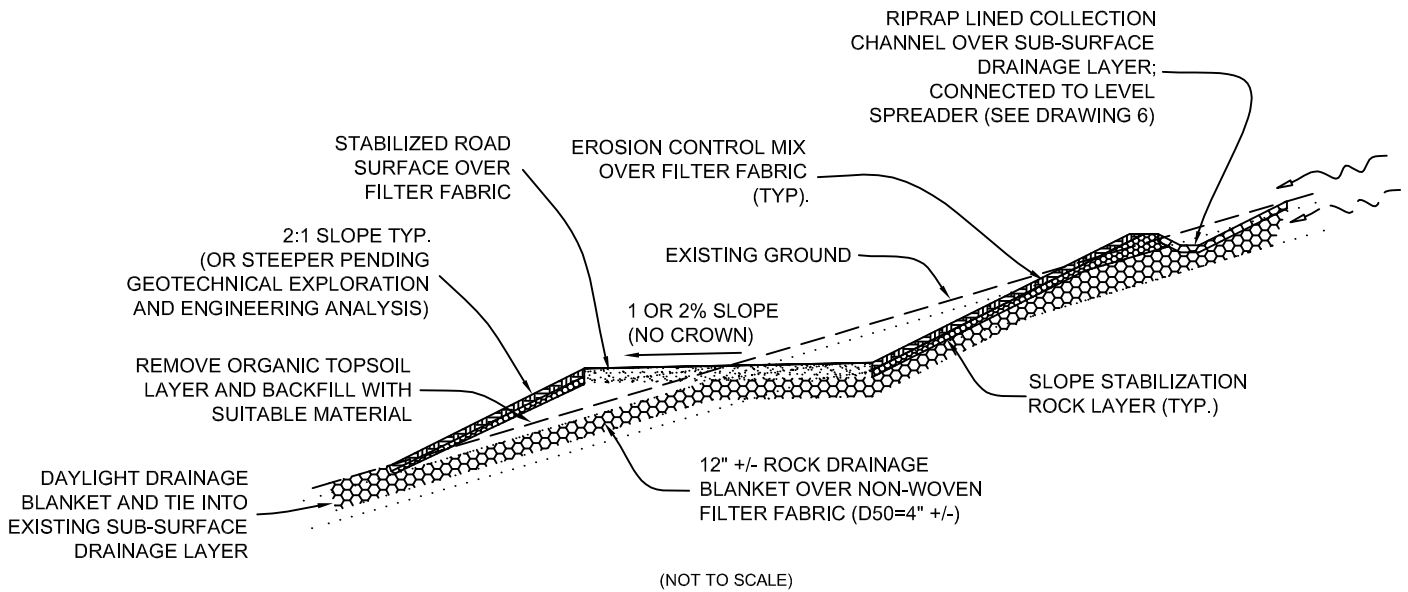

Note: The above drawing represents a situation where the roadway cuts into an existing slope with shallow groundwater; which may be managed using the drainage blanket or trench drains. These measures would not be necessary if the roadway does not cut into the subsurface drainage layer.

<p>Kibby Wind Power Project Franklin County, Maine</p> <p>Original: 11-28-06 Revision 1: 12-05-06 Revision 2: 12-19-06</p>	<p>Road Traversing Existing Slope with Shallow Ground Water (Drainage Blanket)</p>	<p>amec EARTH & ENVIRONMENTAL, INC. ONE PLYMOUTH MEETING, SUITE 850 PLYMOUTH MEETING, PA 19462-1308</p> <p>Drawing 2A</p>
--	---	--

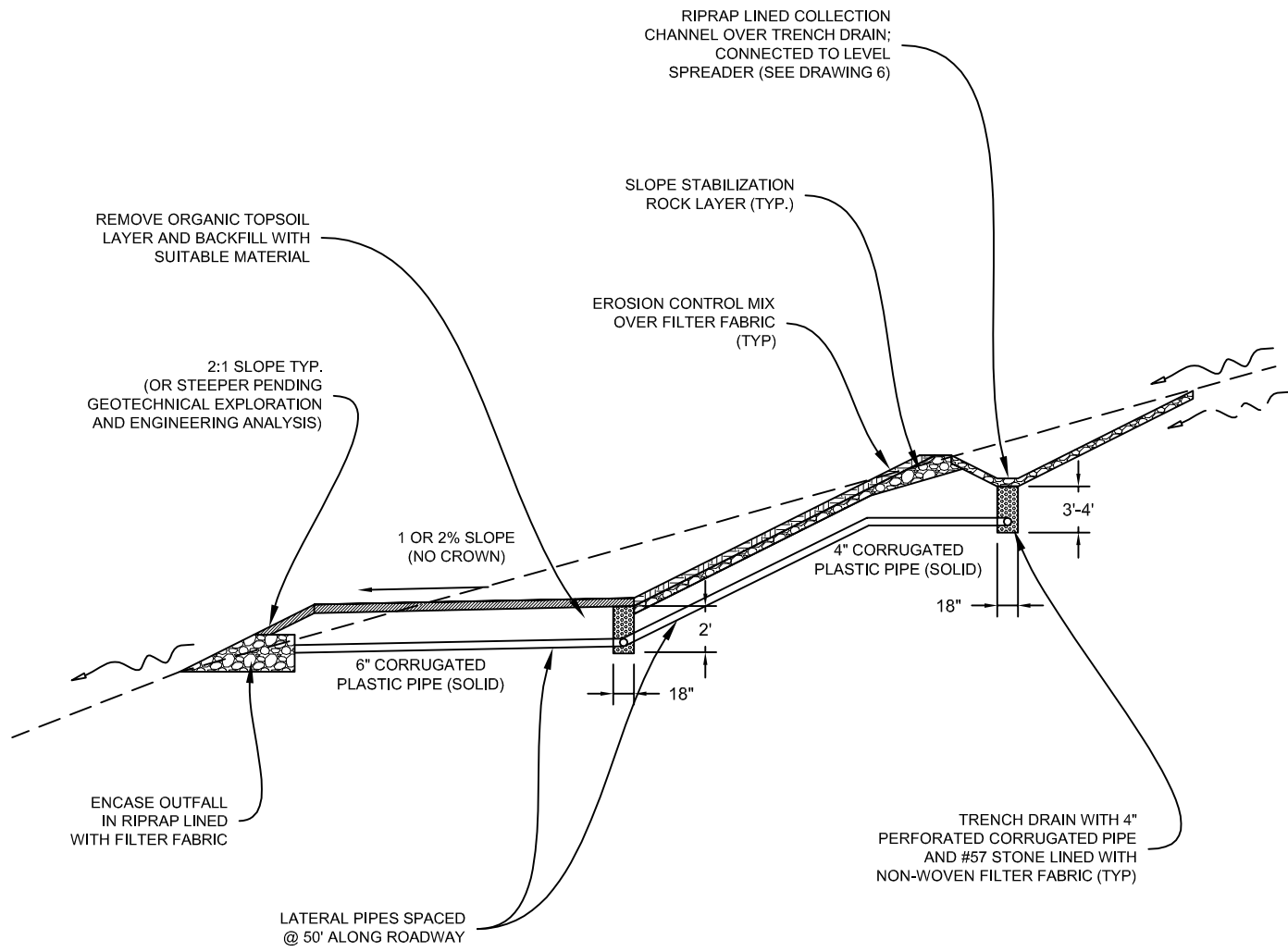

Note: The above drawing represents a situation where the roadway cuts into an existing slope with shallow groundwater; which is managed using the drainage blanket or trench drains. These measures would not be necessary if the roadway does not cut into the subsurface drainage layer.

Kibby Wind Power Project
Franklin County, Maine

**Road Traversing Existing Slope
with Shallow Ground Water
(Trench Drains)**



EARTH & ENVIRONMENTAL, INC.
ONE PLYMOUTH MEETING, SUITE 850
PLYMOUTH MEETING, PA 19462-1308

Original: 12-19-06

Drawing 2B

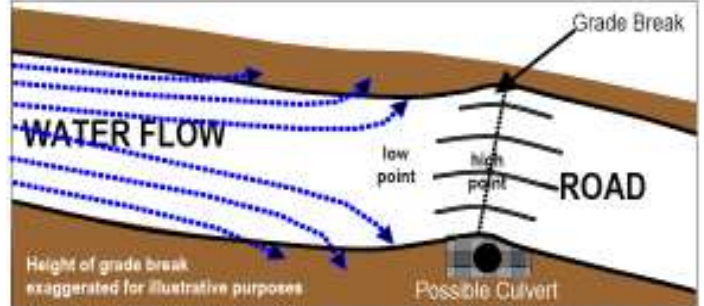
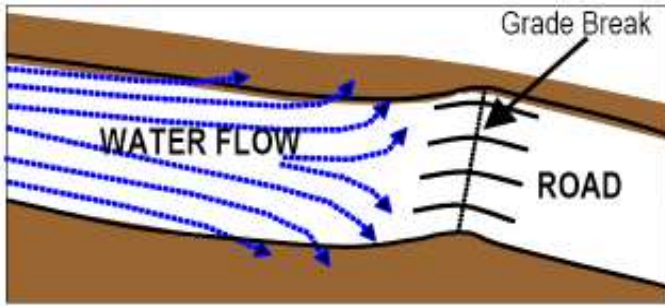

GRADE BREAK – Interruption in slope redirects flow and causes water to leave road area.

REF: PENN STATE CENTER FOR DIRT GRAVEL ROAD STUDIES, TECHNICAL BULLETIN.

Kibby Wind Power Project
Franklin County, Maine

Original: 11-28-06
Revision 1: 12-05-06

Typical Roadway Runoff Drainage Controls



EARTH & ENVIRONMENTAL, INC.
ONE PLYMOUTH MEETING, SUITE 850
PLYMOUTH MEETING, PA 19462-1308

Drawing 8

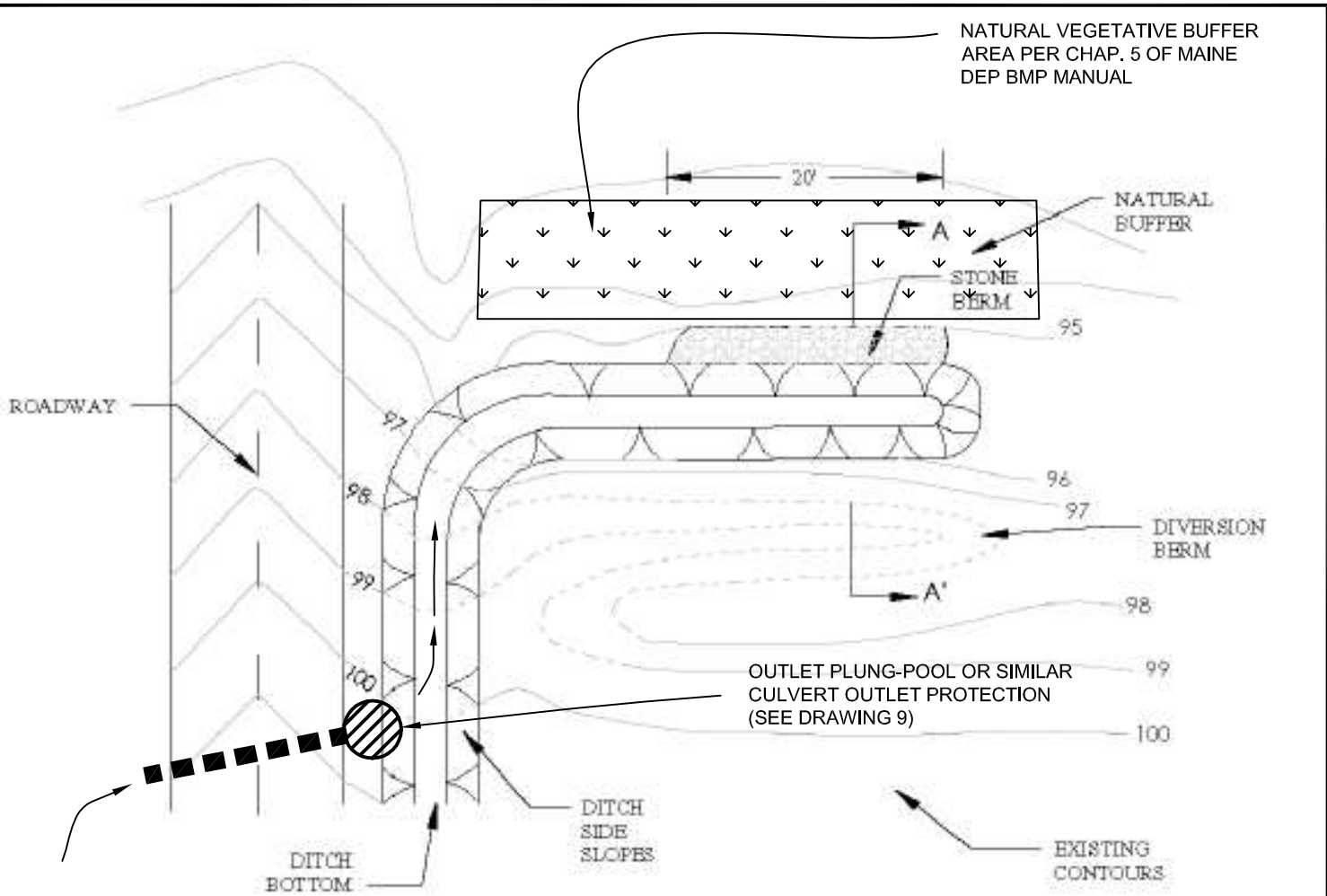

PLAN VIEW
(NOT TO SCALE)

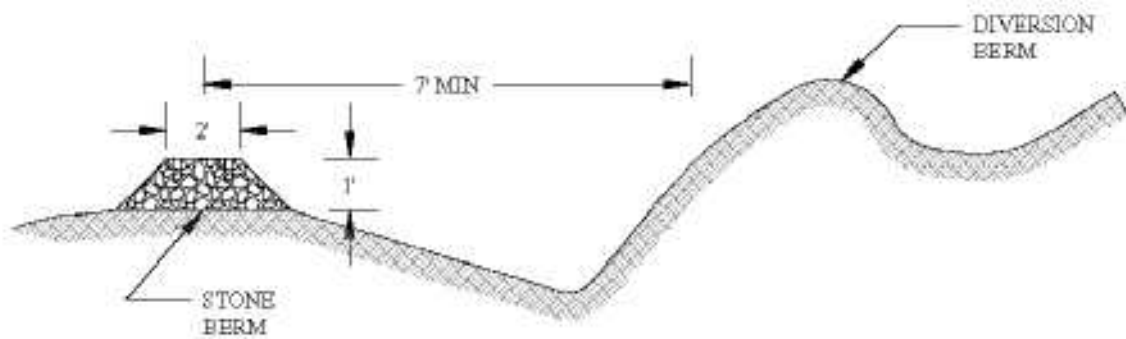

CROSS SECTION A-A
(NOT TO SCALE)

REF: MAINE DEPT. OF ENVIRONMENTAL PROTECTION, BMP TECHNICAL DESIGN MANUAL VOLUME 3 CHAPTER 5.

Kibby Wind Power Project
Franklin County, Maine

Typical Culvert Outfall/ Level Spreader



EARTH & ENVIRONMENTAL, INC.
ONE PLYMOUTH MEETING, SUITE 850
PLYMOUTH MEETING, PA 19462-1308

Original: 11-28-06
Revision 1: 12-05-06

Drawing 6

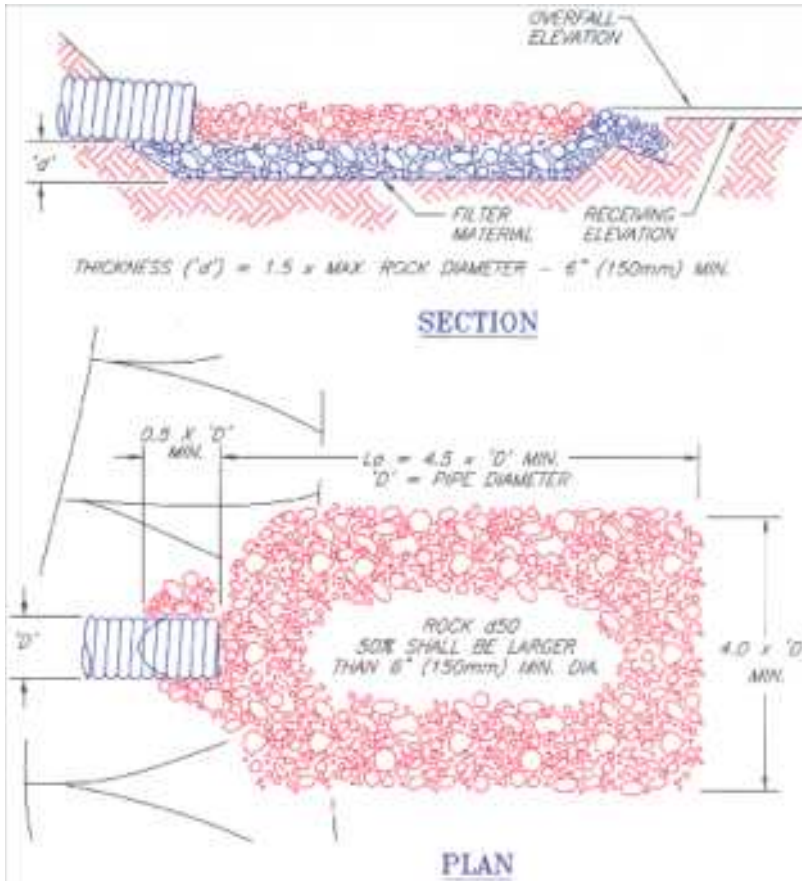

TYPICAL ENERGY DISSIPATOR

(NOT TO SCALE)

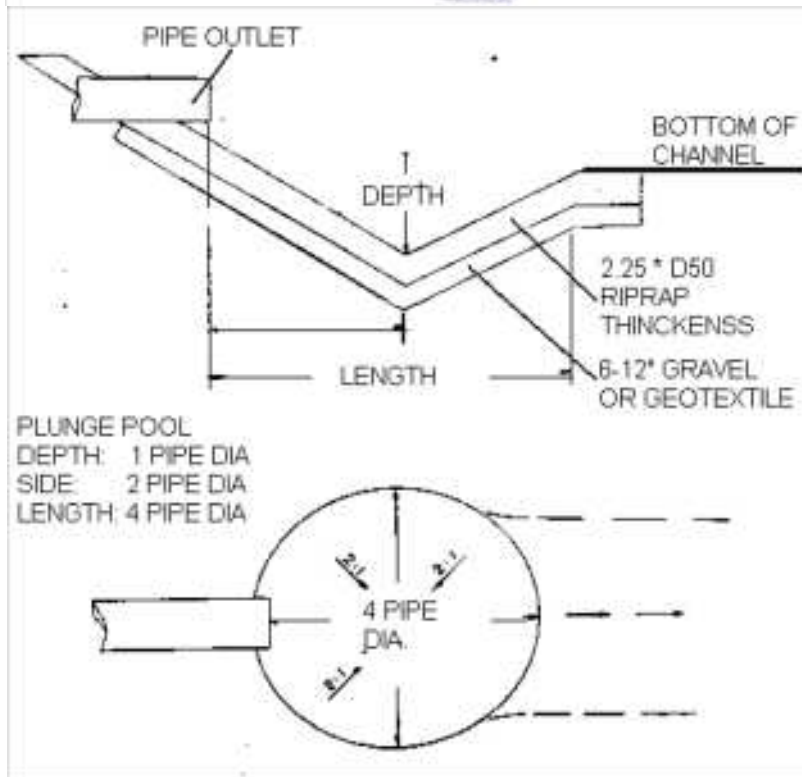

TYPICAL PLUNGE-POOL

(NOT TO SCALE)

REF: MAINE EROSION AND SEDIMENT CONTROL BMP MANUAL

Kibby Wind Power Project
Franklin County, Maine

**Typical Culvert
Outlet Protection/
Energy Dissipation**



EARTH & ENVIRONMENTAL, INC.
ONE PLYMOUTH MEETING, SUITE 850
PLYMOUTH MEETING, PA 19462-1308

Original: 11-28-06
Revision 1: 12-05-06

Drawing 9

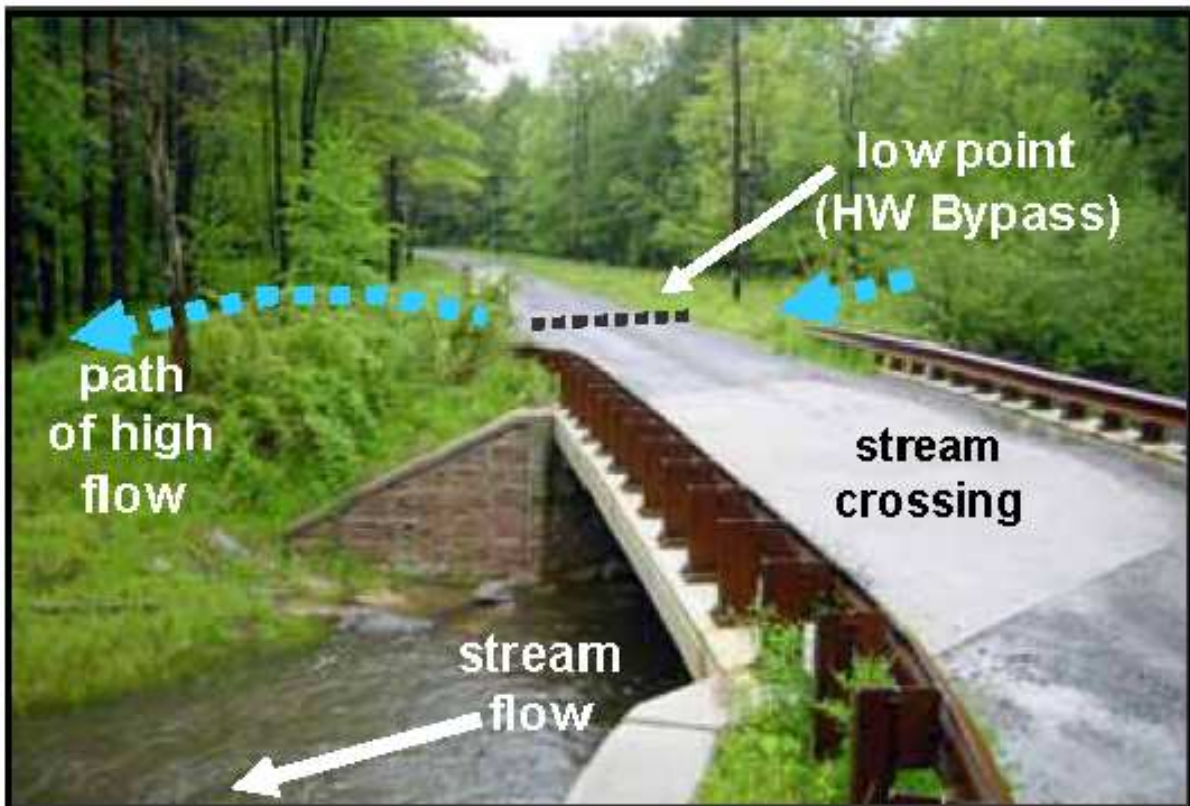
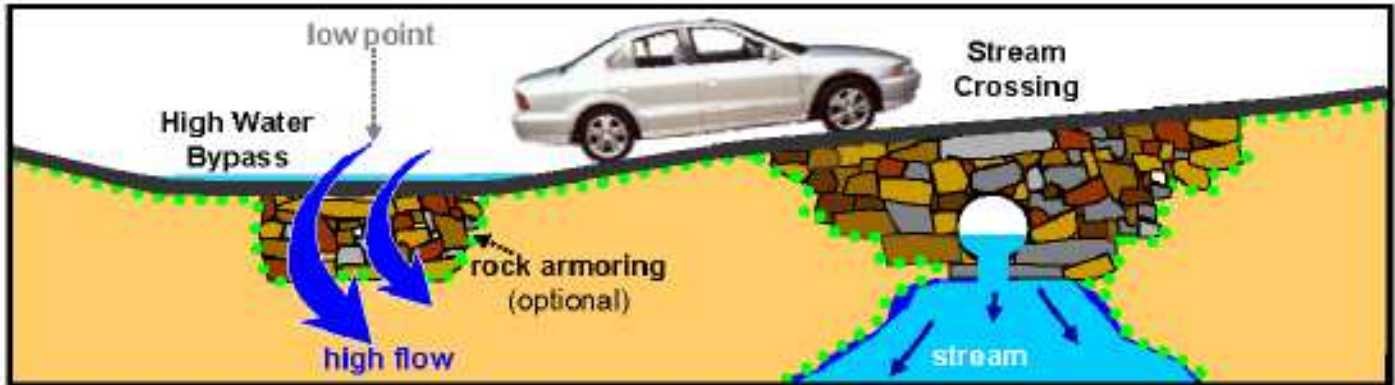

Photo 1: The low point in the above site is away from the stream. Little reinforcement was needed at this site because of the relatively flat terrain.

REF: PENN STATE CENTER FOR DIRT GRAVEL ROAD STUDIES, TECHNICAL BULLETIN.

Kibby Wind Power Project
Franklin County, Maine

Typical Stream Crossing



EARTH & ENVIRONMENTAL, INC.
ONE PLYMOUTH MEETING, SUITE 850
PLYMOUTH MEETING, PA 19462-1308

Original: 11-28-06
Revision 1: 12-05-06

Drawing 7

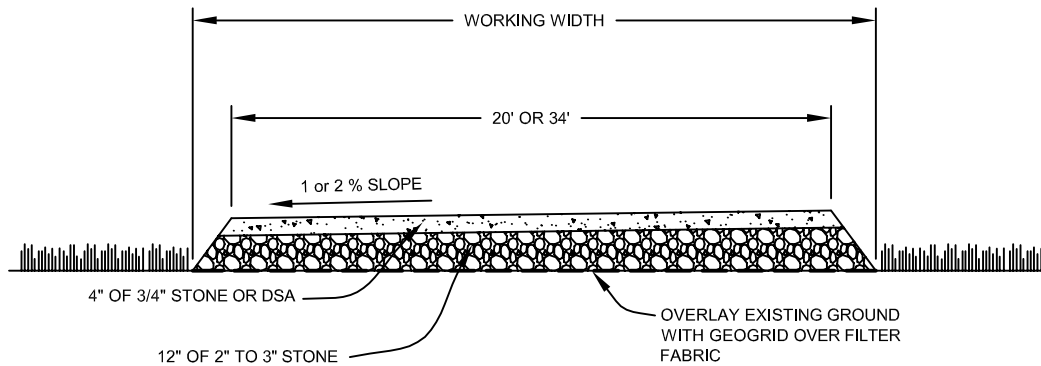

(NOT TO SCALE)

Kibby Wind Power Project
Franklin County, Maine

Original: 11-28-06
Revision 1: 12-05-06

Typical Road Section when Crossing Wet Areas



EARTH & ENVIRONMENTAL, INC.
ONE PLYMOUTH MEETING, SUITE 850
PLYMOUTH MEETING, PA 19462-1308

Drawing 5

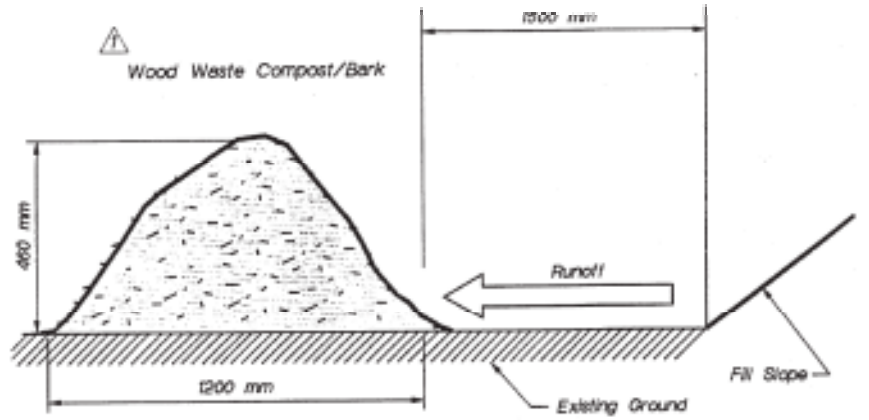

NOTE:

Wood Waste Compost/Bark Filter Berms may be used in combination with Silt Fence to improve sediment removal and prevent clogging of the Wood Waste Compost/Bark Berm by larger sediment particles. (Silt fence placed to filter runoff before Wood Waste Compost/Bark)

FILTER BERMS

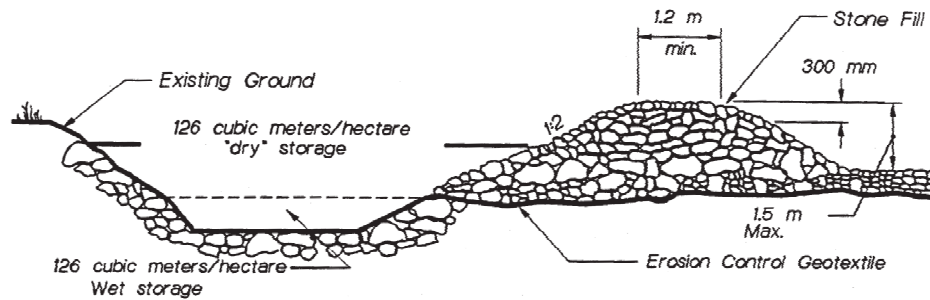

CROSS SECTION

(@ \perp of Outlet)

TOP WIDTH OF SEDIMENT TRAP OUTLET SHALL FUNCTION AS A LEVEL SPREADER; WIDE ENOUGH TO PASS A MAXIMUM FLOW OF 0.1 CFS PER FT OF WIDTH

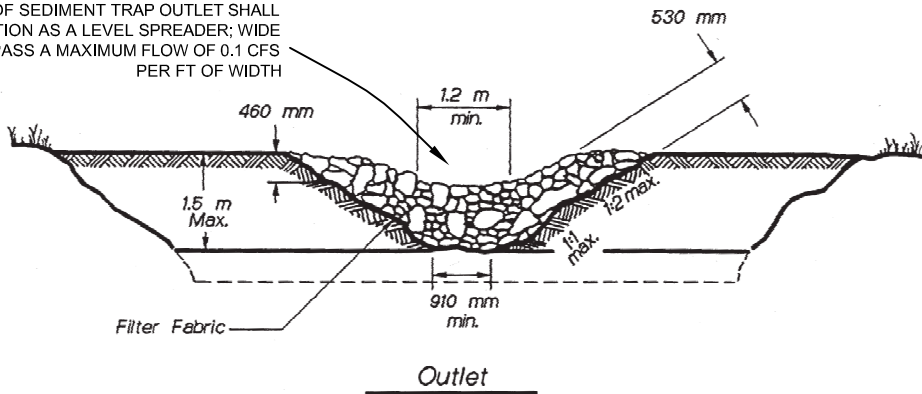

SEDIMENT TRAP @ LEVEL SPREADERS

REF: MAINE DEPT. OF TRANSPORTATION, EROSION AND SEDIMENT CONTROL STANDARDS.

Kibby Wind Power Project
Franklin County, Maine

**Typical Erosion and
Sediment Control
Measures**



EARTH & ENVIRONMENTAL, INC.
ONE PLYMOUTH MEETING, SUITE 850
PLYMOUTH MEETING, PA 19462-1308

Drawing 10

Original: 11-28-06
Revision 1: 12-05-06

In accordance with DEP Chapter 500, measures were included in the design to mitigate potential impacts to stormwater quality and quantity. The categories of stormwater standards that could apply to projects disturbing one or more acres include: “basic,” “general,” “flooding,” and/or “urban impaired streams.” There are no urban impaired streams in Franklin County, so this standard would not apply. However, the remaining three standards apply to projects involving three or more acres of impervious areas or 20 or more acres of developed area (as is the case for this project). The “basic standard” consists of erosion and sedimentation control measures during construction; inspection and maintenance; and housekeeping measures. The “general standard” applies best management practice (BMP) standards and phosphorus standards to address post-construction water quality. The “flooding standard” mitigates for post-construction increases in peak runoff flow rates for the 2-, 10-, and 25-year/24-hour storms.

To address the “basic standards,” runoff from disturbed areas passes through erosion and sediment control measures before leaving the site. To the extent possible, overland (sheet) flow will be maintained during and after construction. Accordingly, erosion and sediment control of construction-related runoff will primarily be managed through the use of temporary sediment barriers, which essentially consist of mulch filter berms. Where concentrated flow is unavoidable, temporary sediment traps will be used to trap sediment-laden runoff during construction. Off-site runoff will be collected in diversion channels and conveyed around and through the construction site to minimize the quantity of runoff entering the construction site. Off-site runoff will be conveyed through cross-culverts and re-distributed with level spreaders to create a stable outfall. All perimeter controls, including the off-site diversion channels and culverts, filter berms and sediment traps, will be installed prior to commencing earthwork activities. Temporary diversion berms will be used, as necessary, to temporarily direct construction runoff to the traps. Natural, undisturbed vegetative buffers will be maintained down-slope of sediment barriers and traps to further filter out the sediment-laden runoff.

Stabilization of graded areas is also a key element of proposed erosion and sediment control during construction. Details regarding seed mixes, and other stabilization methods, are discussed in Section 8.6. As recommended by the Maine State Soil Scientist, DEP’s Erosion Control Mix will be used to cover and stabilize many of the cut and fill slopes. At higher elevations, use of natural revegetation methods will be used as appropriate.

The “general standard” will be applied for post-construction water quality by diverting off-site (clean) runoff around the site and re-distributing the flow over level spreaders. Similarly, on-site runoff will either be directed over a vegetated buffer via overland flow or collected in channels and then directed through level spreaders and vegetated buffers with the shortest spacing possible. Frequent release of off- and on-site runoff will sometimes not be feasible, particularly along roadway switchbacks. In such cases, flow splitters will be placed along the channels to distribute the concentrated flow before releasing the stormwater over level spreaders. Phosphorus export control is also required for the “general standard.” Vegetated buffers will also be used to treat runoff for phosphorus, as discussed in Section 8.6.

To address the “flooding standard,” a hydrologic analysis was conducted for the 2-, 10- and 25-year/24-hour storms. In general, the project will result in slight increases of approximately 1 percent or less, or decreases in peak flow rates. Decreases in peak flow rates typically occurred due to increased time-of-concentration created by channel diversions.

Stormwater management, including phosphorus control, is addressed in greater detail in Section 8.6 and Appendix 2-K.

The preliminary design for the stormwater management during operation has been based on:

- DEP’s Chapter 500 Rules, Stormwater Management, Revised November 16, 2005 and December 7, 2006.
- DEP’s Stormwater Management for Maine, Volume I – Stormwater Management Manual, January 2006.
- State of Maine, DEP, Stormwater Management for Maine, Volume III – BMPs Technical Design Manual, January 2006.
- State of Maine, DEP, Erosion and Sediment Control BMP Manual, March 2003.
- State of Maine, DEP, Phosphorus Control in Lake Watersheds. A Technical Guide for Evaluating New Development (1992).
- State of Maine, DEP, Erosion and Sediment Control BMP Manual (March 2003).
- Maine Land Use Regulation Commission, Chapter 10 of the Commission’s Rules and Standards, November 7, 2005.

2.4.3.3 Meteorological Towers

Permanent met towers will be incorporated into the project for use in ongoing resource monitoring. The specific locations of these towers will be determined based upon final layout and operational assessment needs. If required, the met towers will utilize a similar design employed for the three met towers currently located at the site (Figure 2-21). The heights of the permanent met towers will be designed such that measurements are taken at precise turbine hub height. Locations for the permanent met towers would not require new impact area, as they would be co-located with proposed turbine activity in selected locations.

2.4.3.4 Electrical System

The electricity generated by each turbine must be collected and transmitted to the existing power transmission system (the grid). It will require the construction of an electrical collection system, substation and – as will be discussed in Volume V – a 115 kV transmission line.



Figure 2-21. Existing Met Tower

The purpose of the electrical collection system (shown in Figure 2-22) is to interconnect the individual wind turbine to a single exit power line. Collector lines will be buried from the turbine base through the turbine pad area to the edge of the road where they will connect above grade to the pole line system between the turbines. For each ridgeline series, the collection system will consist of two 34.5 kV, three-phase cable systems on overhead poles along the turbine access roadways. Collector pole height will be approximately 60 feet (18 m). Typical collector designs are presented in Figure 2-23. Pole placement has prioritized avoidance of wetland areas, as can be seen from Figure 2-22.

The A Series and B Series collector systems will each deliver the gathered electricity to the proposed Kibby Substation, located on Wahl Road, via collector lines from the ridgelines to the substation. The Series A collector system will extend from the southerly portion of the ridgeline at Spencer Bale Road through recently cut areas, crossing Hurricane Road and Kibby Stream to access the Kibby Substation. For Series B, the collector system will extend from the southwesterly portion of the ridgeline through recently cut areas, to co-locate briefly with the proposed 115 kV transmission corridor (discussed in Volume V) before connecting to the Kibby Substation. As for the ridgetop pole placement, wetlands have been avoided to the extent possible as the lines extend to the Kibby Substation.

The collector system, as it leaves the proposed roadway corridor, will require a cleared right-of-way that will be 60 feet (18 m) in width. Following construction, the right-of-way will be allowed to revegetate with low-growing species. Future maintenance of this cleared right-of-way will be performed by crews on foot and using all-terrain vehicles (ATV). A buffer will also be maintained on Kibby Stream.

Along with the three-phase electrical transmission wires, fiber optic communication cabling for the System Control and Data Acquisition (SCADA) system that controls, monitors, and collects performance data from each turbine will be strung on the same poles.

The wood poles will be delivered to the turbine string corridor by a pole trailer. An ATV would drill an 8-foot (2.4 m) deep, 24-inch (0.6 m) diameter hole. The poles would then be installed and backfill would be placed. In rock, a pilot hole would be drilled, and the rock blasted then excavated. The small amount of excess soil or blasted rock would be used for fill in other areas.

2.4.3.5 Substation

The Kibby Substation will be located along Wahl Road (shown in Figure 2-22). The substation will consist of a 215- by 415-foot (65.5-m by 126.5-m) fenced area, including a grounding mat, and will contain the main 34.5 kV-to-115 kV step-up transformers, connection points for the incoming and outgoing power lines, and small weather-protected enclosures for backup power generation, SCADA connection and other communication needs. A drawing of the proposed substation design is provided in Figure 2-24; a representative substation photograph is provided in Figure 2-25. Access to the substation will be via a short driveway off of Wahl Road. The total disturbed area is approximately 3 acres.